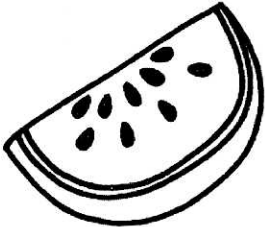
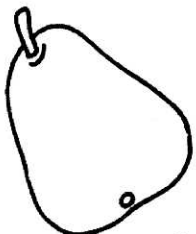
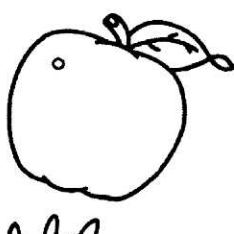
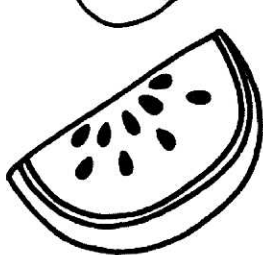

 +  =

 +  =

 +  =

 +  =

 +  =

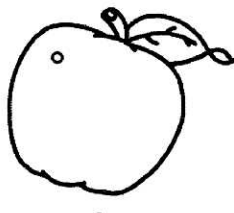
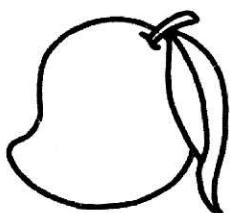
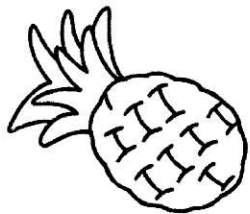
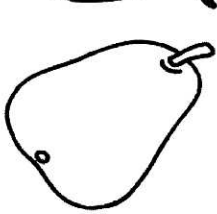
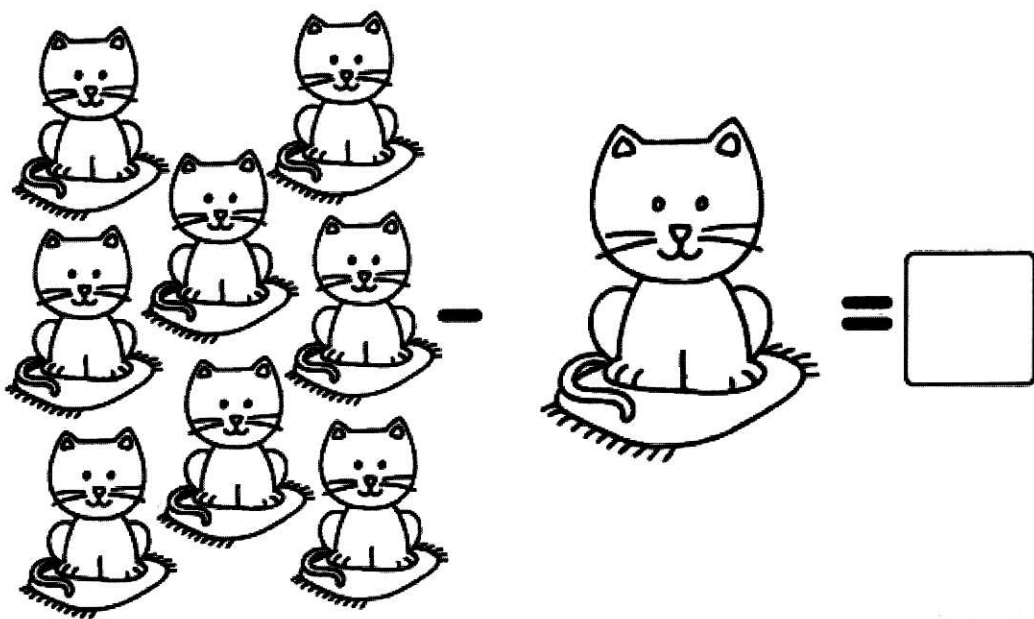
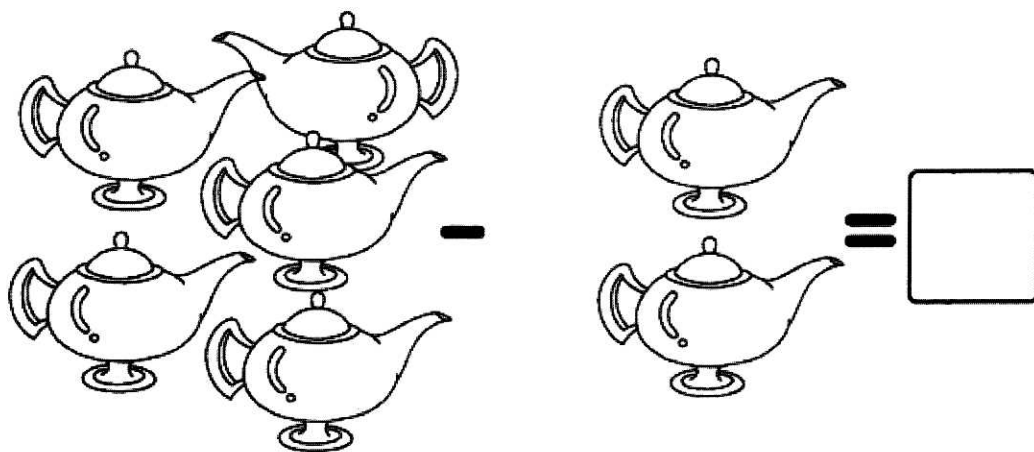
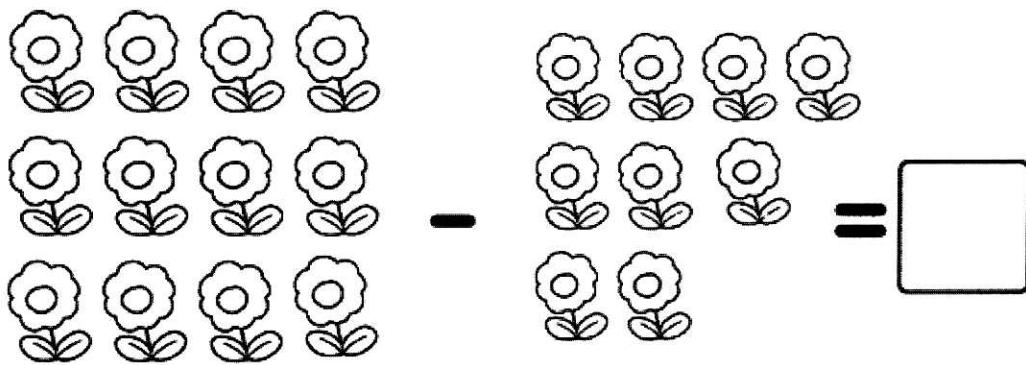

© 2019 by uroki

• Впиши недостающие цифры. Раскрась только тех рыбок, на спинках которых по семь чешуек.

7	
7	0
0	
6	1
1	
5	
2	
4	
3	

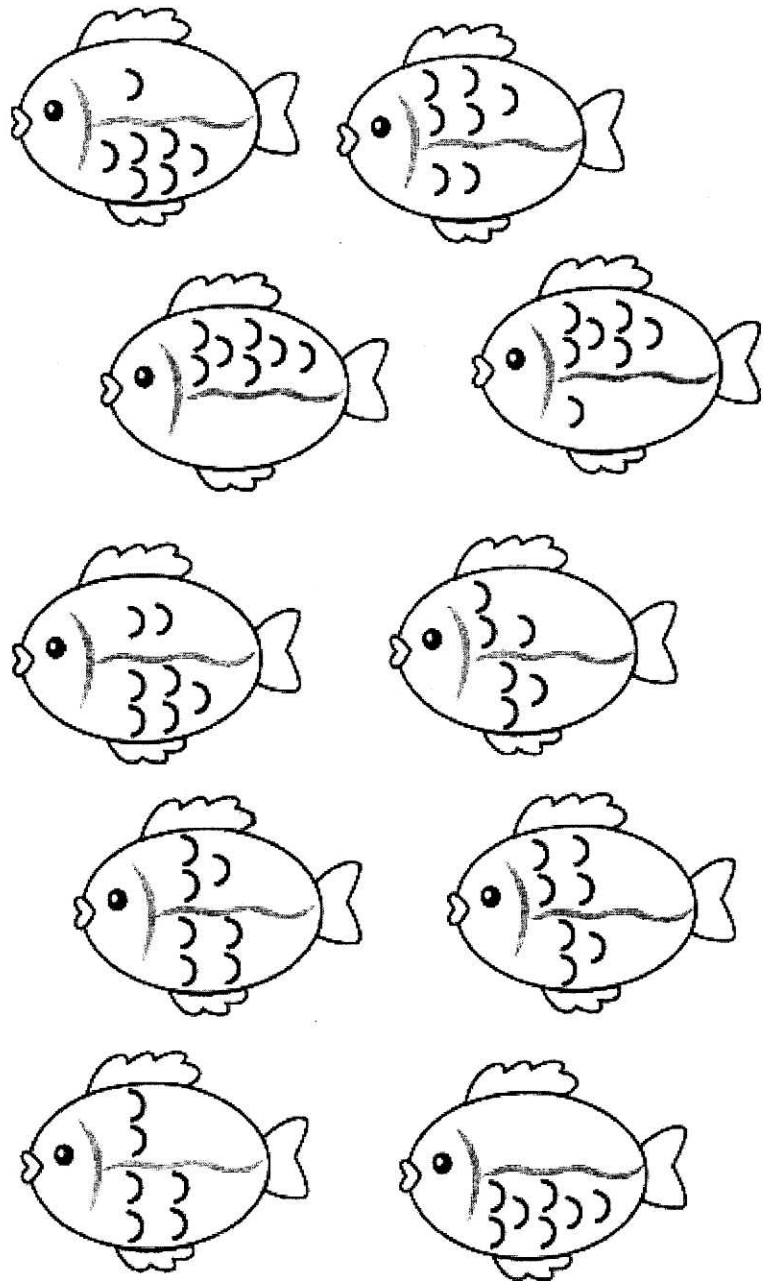

ВЫСОКИЙ - НИЗКИЙ. Сравни предметы.

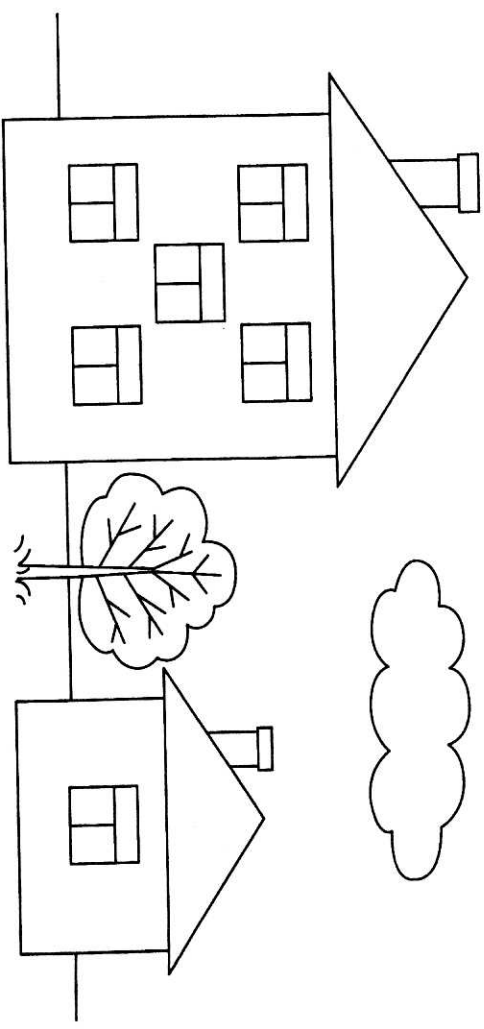

Обведи только высокие предметы.

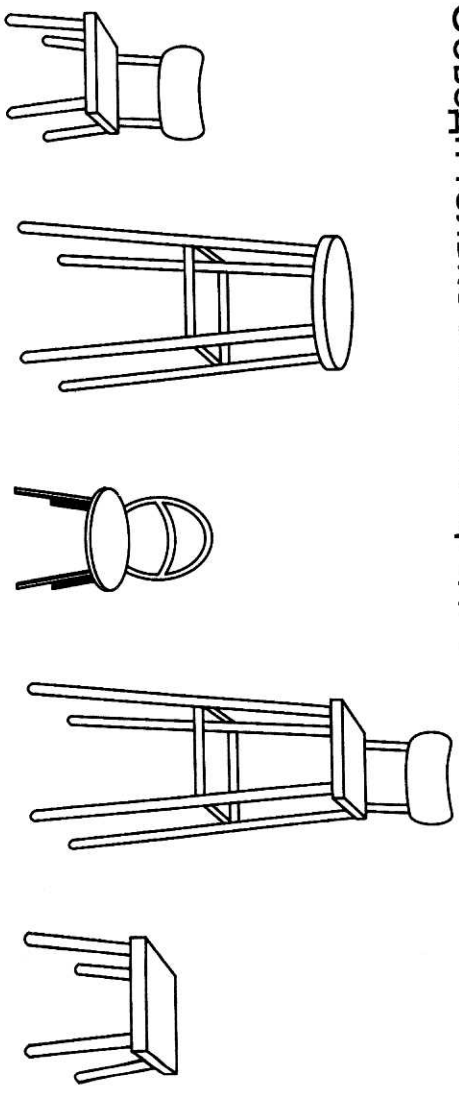

Скажи наоборот.

Веселый дедушка - ...

(густная ячнудл)

Зачеркни лишние вагончики.

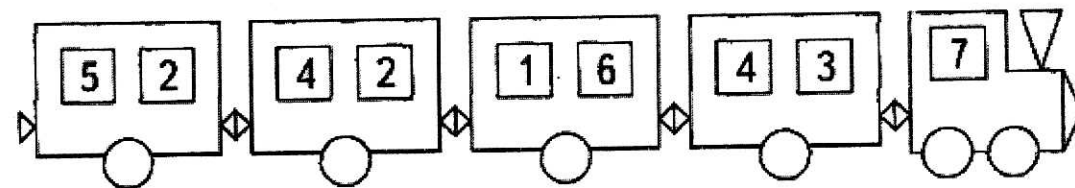
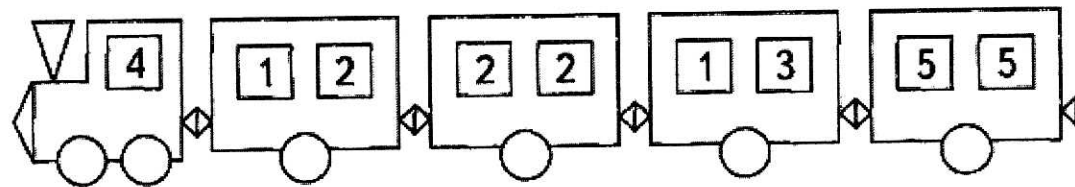
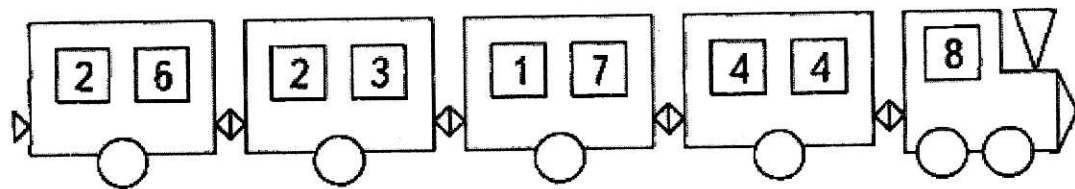
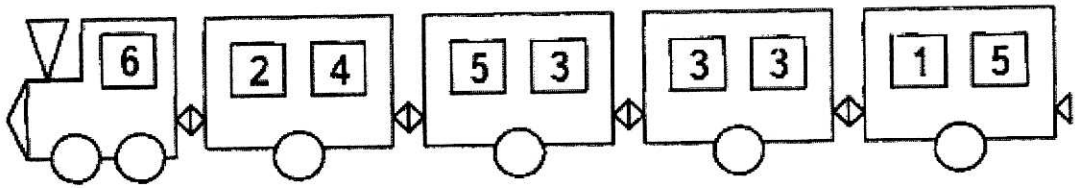

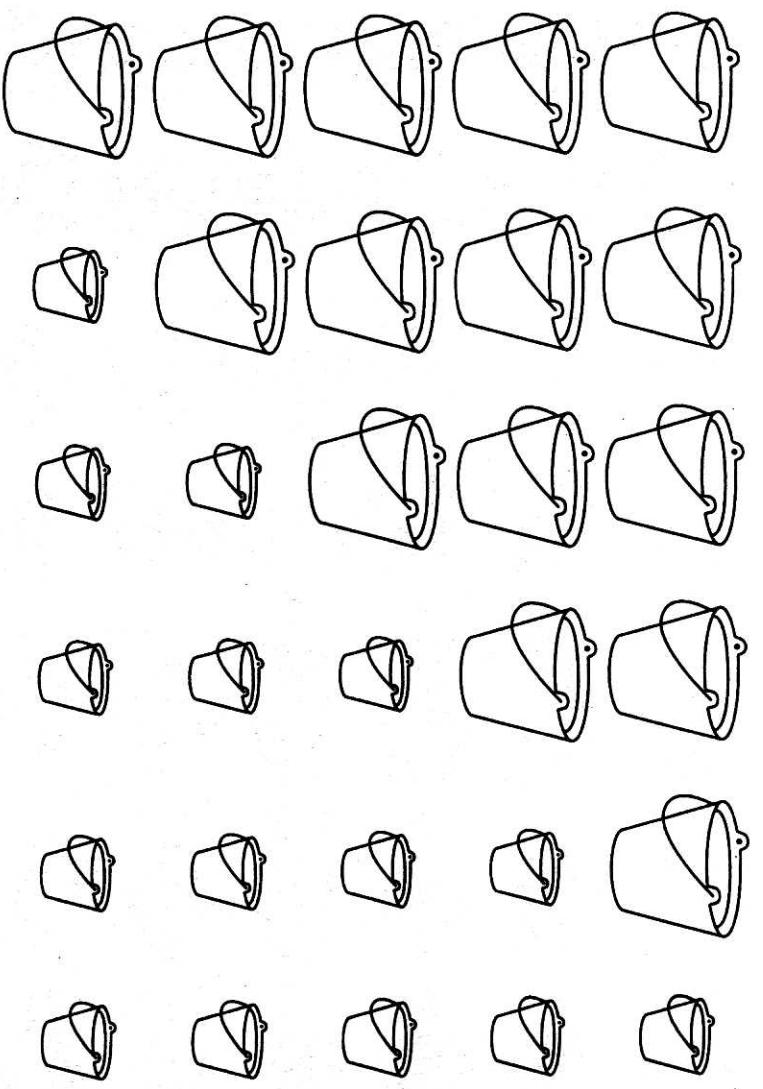

Как составлено число шесть? Назови все варианты.

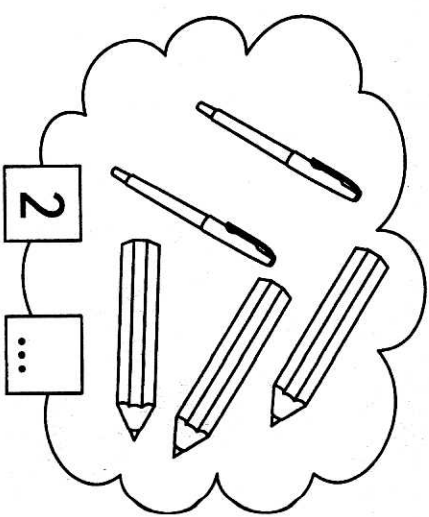
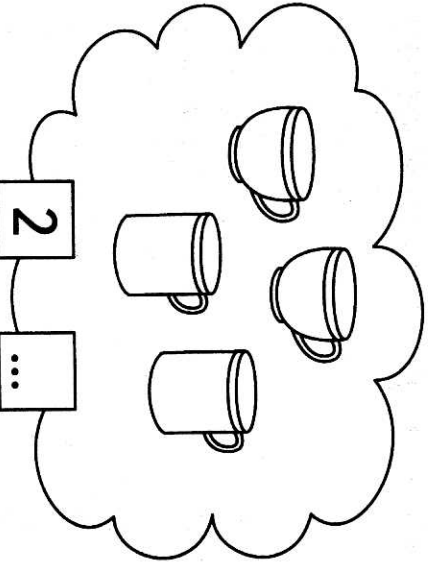

Впиши пропущенные цифры.

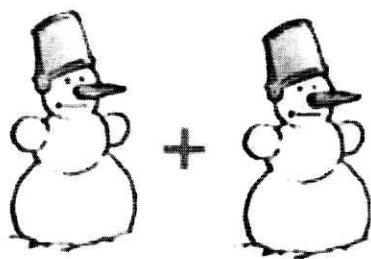

Реши примеры.
Запиши ответы в клеточки.

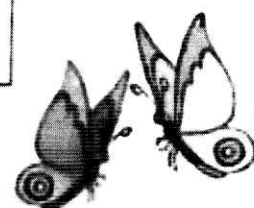
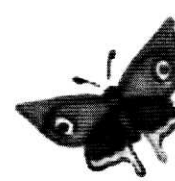
 +  =  +  =

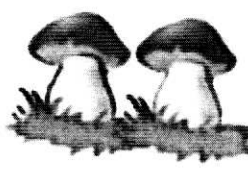
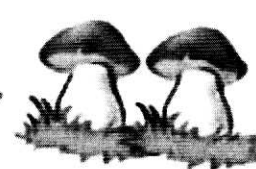
 +  =

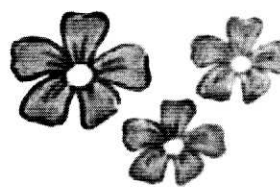
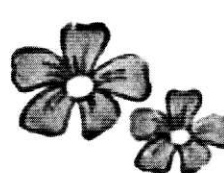
 +  =

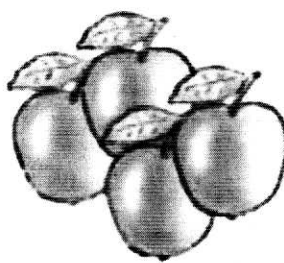
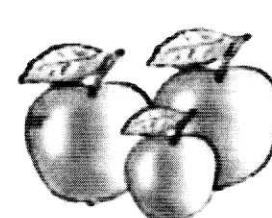
 +  =

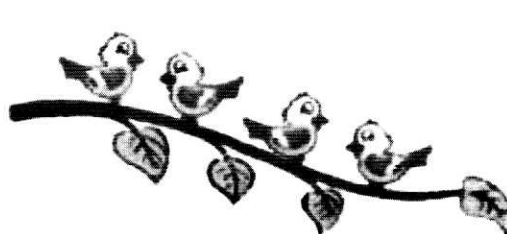
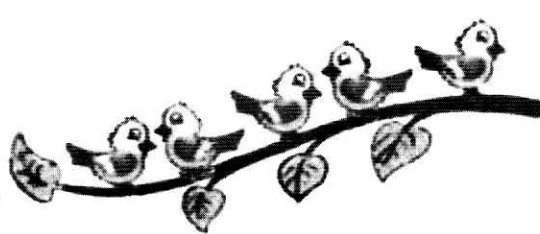
 +  =

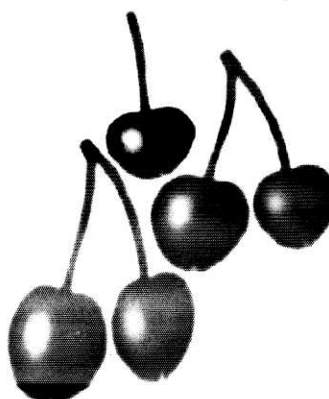
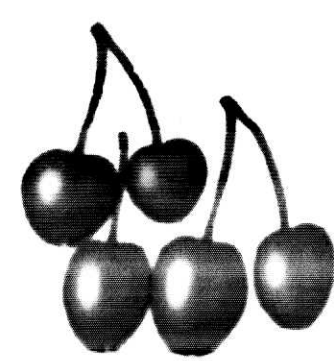
 +  =

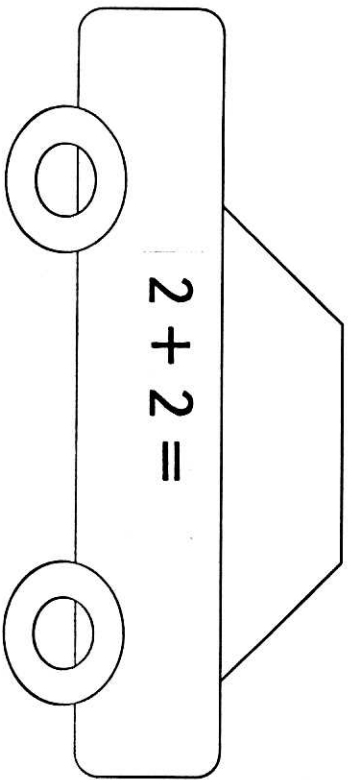
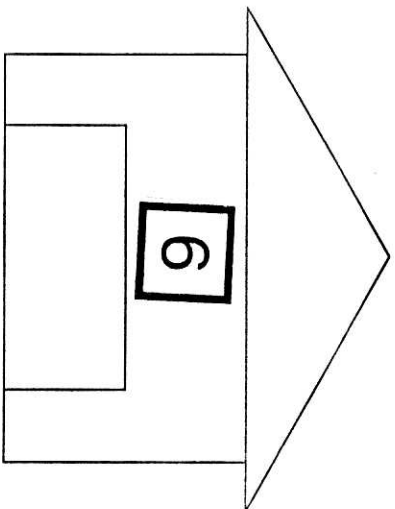
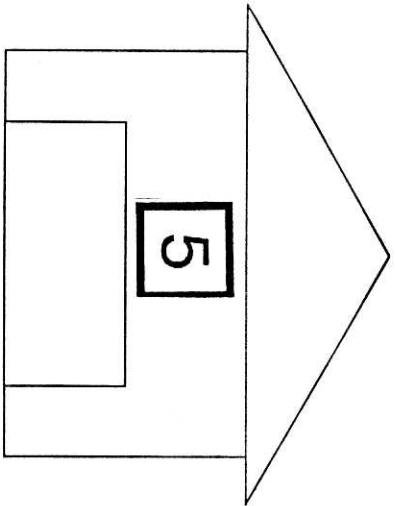
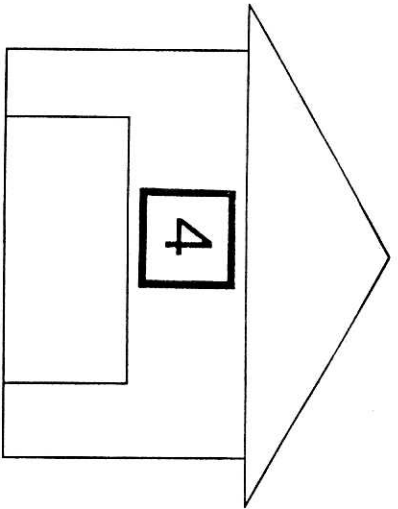

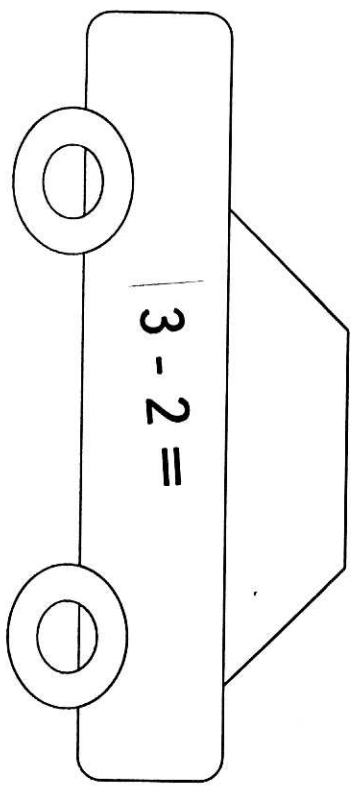
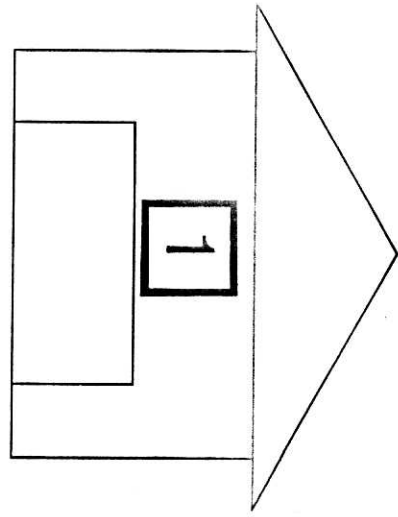
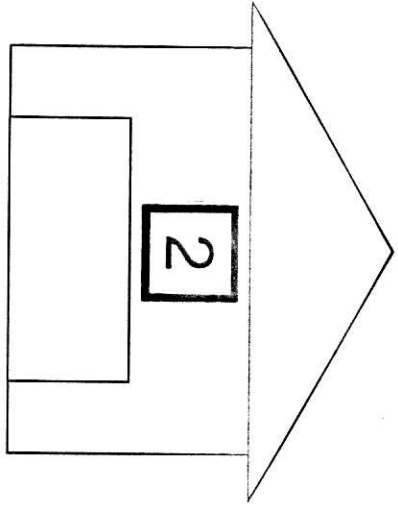
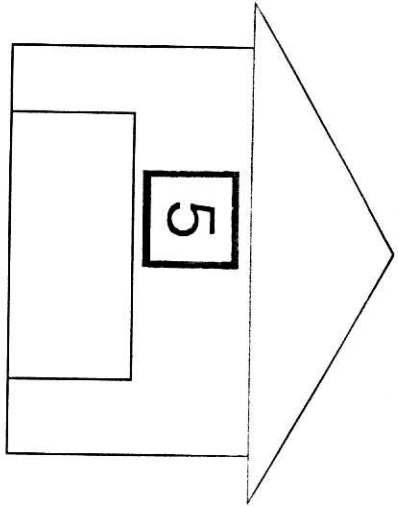

Нахождение ошибки. Геометрические фигуры

Закрась лишнюю фигуру.

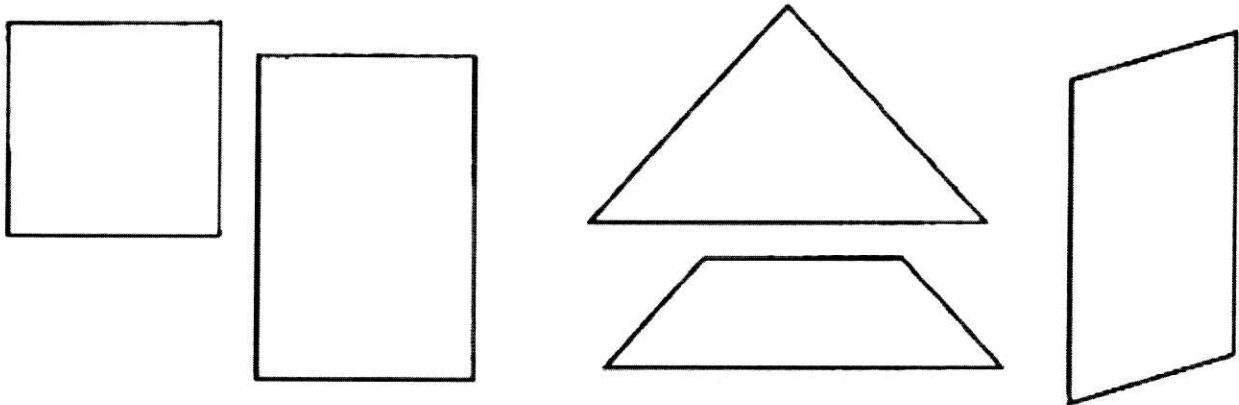

Закрась лишнюю фигуру.

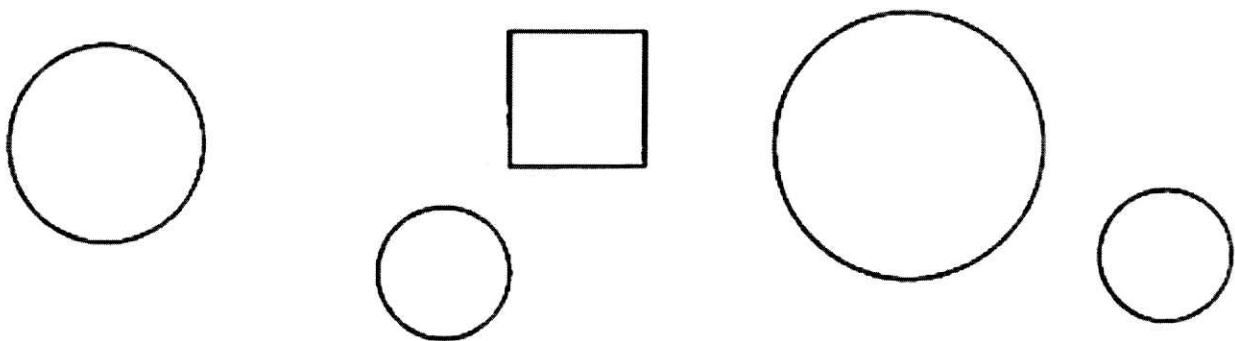

Закрась лишнюю фигуру.

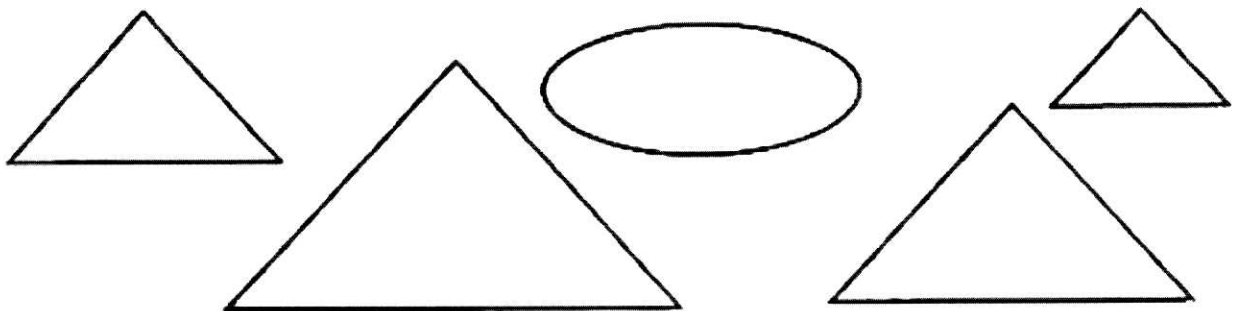

Вставь пропущенные числа

Догадайся, как нужно расставить числа в домиках.

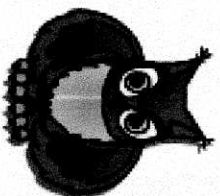
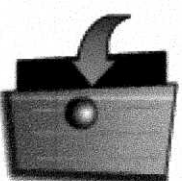
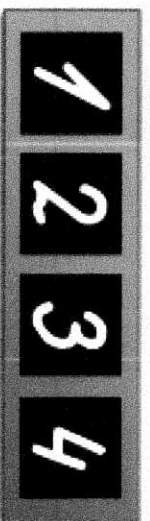
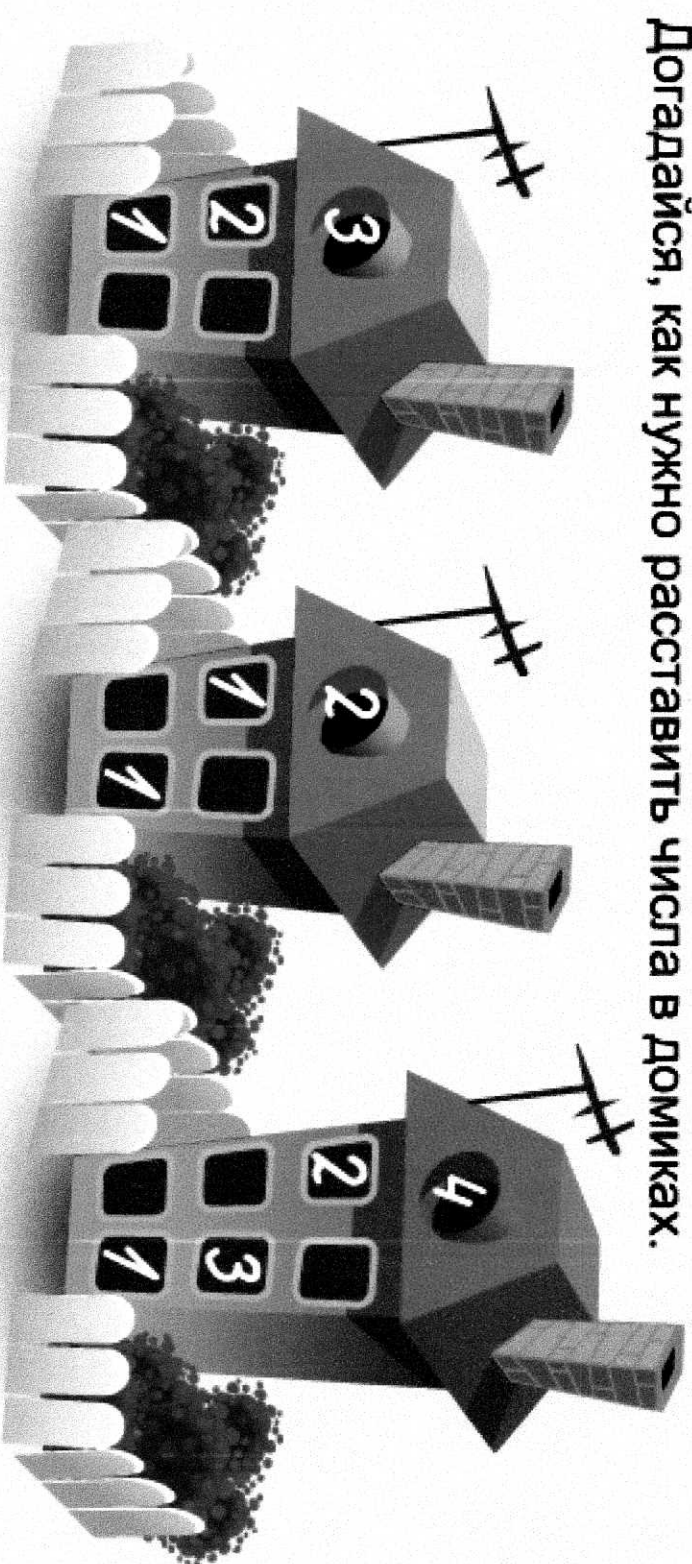

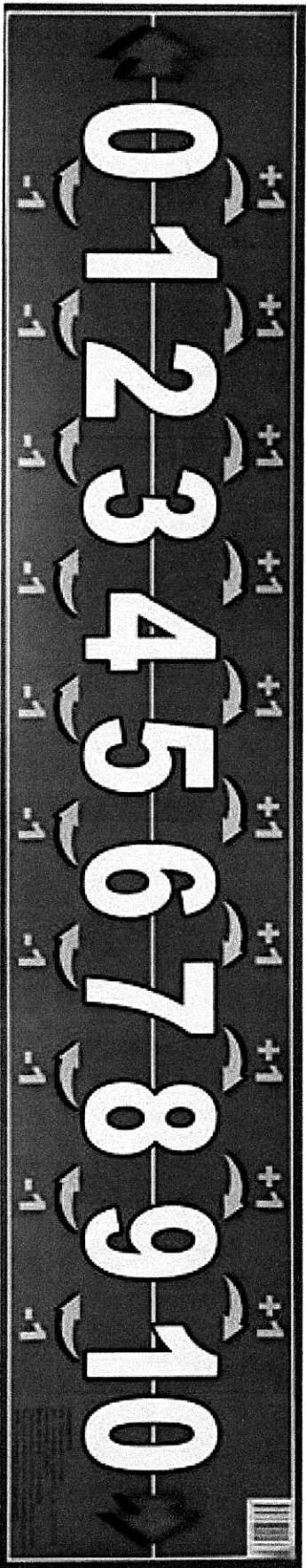

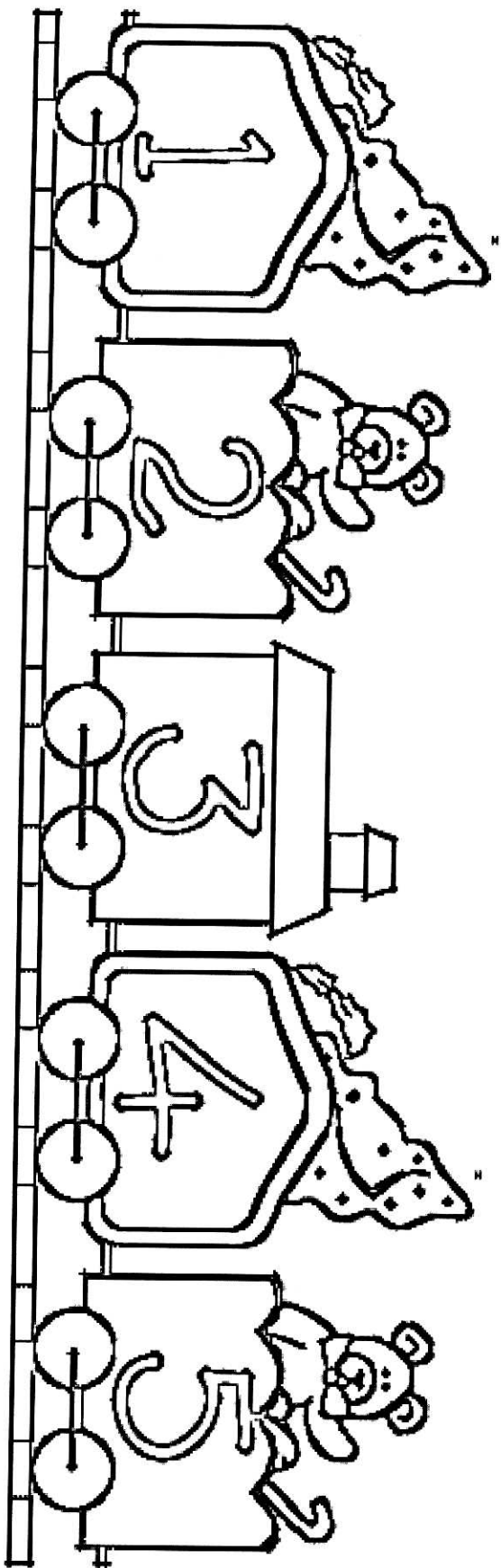
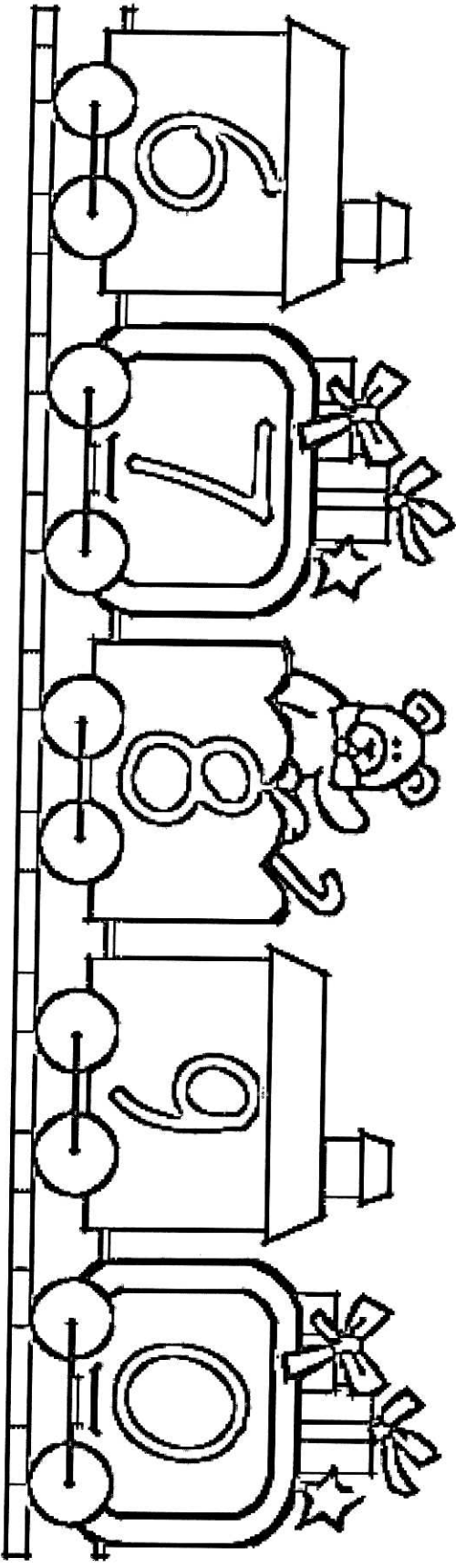

Назови количество
предметов слева, назови справа.
Сделай так, чтобы было
поровну. (Дорисуй необходимое кол-во)

Дата: _____

Имя: _____

